



Calnetix Technologies Company Overview

Leading Motoring and Generating Technologies
for High-Speed OEM Systems



Innovation That Drives Industries®

Innovation That Drives Industries®

Calnetix Technologies is making a positive contribution to society and the environment by helping to change the way the world harvests and utilizes energy.

In partnership with original equipment manufacturers (OEMs), we utilize our innovative, high-speed motor generator technologies to help meet industry demand for more energy-efficient systems that reduce energy consumption, reduce harmful emissions and enhance energy security.

Our motor generator, magnetic bearing and power electronics technologies and our system integration and project execution expertise enable OEMs to develop superior products in industries as varied as medical, food and marine. In this way, our employees have the unique opportunity to provide Innovation That Drives Industries®.

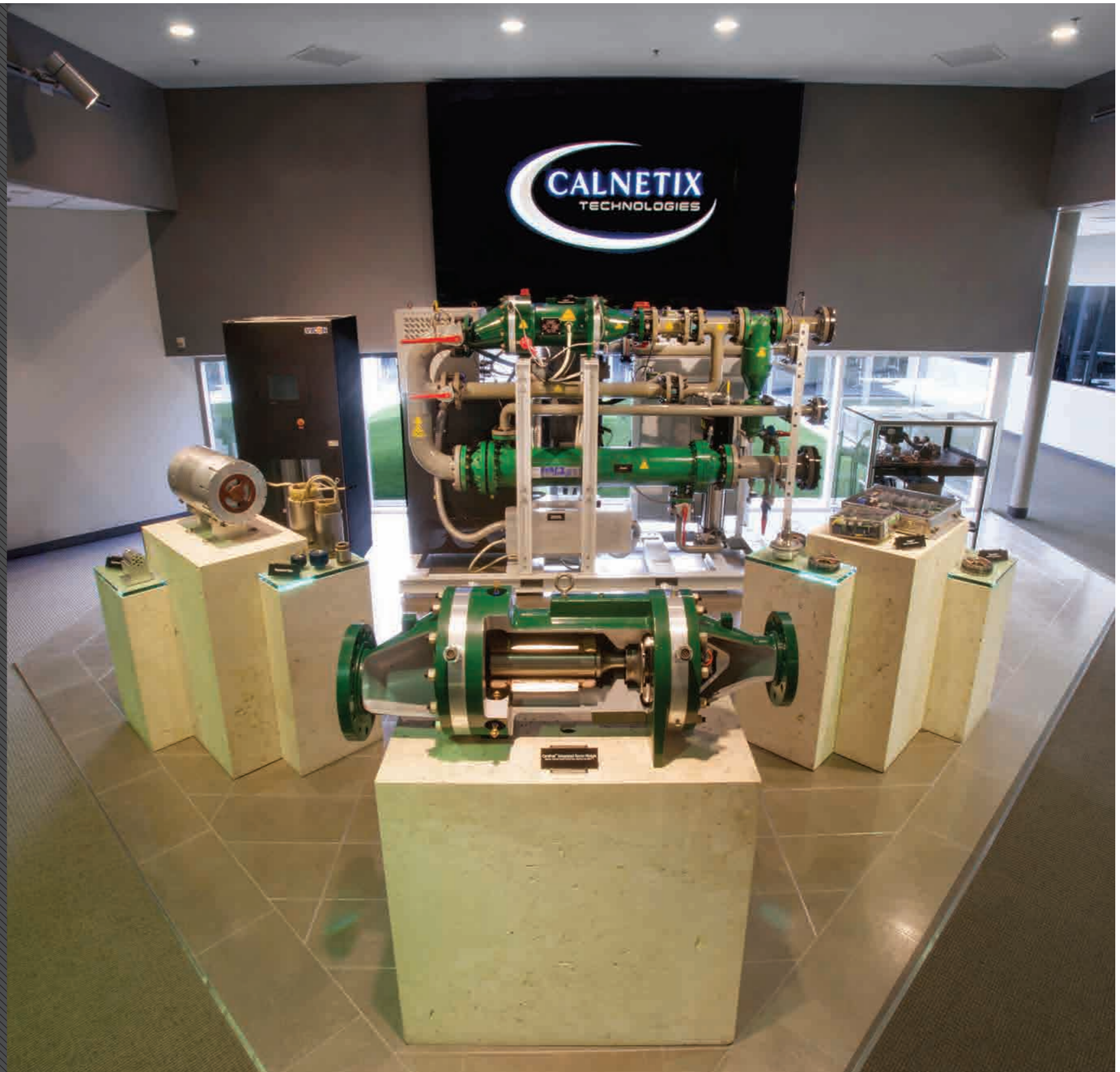



Innovation That Drives Industries®

Total In-House, High-Speed System Offering: Motor Generators, Magnetic Bearings and Power Electronics

Calnetix Technologies specializes in high-performance, high-speed motor generators, advanced magnetic bearings and high-frequency power electronics. Innovation in these disciplines is driven by our competitive spirit and our significant investment in research and development activities, which have led to numerous patents and technical advancements in our core products that continue to keep us ahead of the competition.

Combining our products and capabilities, we provide comprehensive integration services to assist customers in the design, development and production of the most energy advanced systems.

Vast Array of Designs for Applications Across a Broad Range of Industries

From our inception in 1998, the main focus at Calnetix has been to understand the customer, end user and application requirements and to leverage our high-speed technologies, expertise and experience to meet those requirements and exceed customer expectations.

This focus has made us a leading supplier of custom motor generators for OEMs in a wide range of applications and industries, as shown in the chart below.

Subsidiaries and Affiliates

Calnetix Technologies' research and development team internally derives and develops technological innovations for lucrative markets. These innovations are largely focused on subsystems that easily integrate into OEM systems to provide value-added products to end users. Once concepts are validated, in some cases, they are further developed and supplied through strategic subsidiary or affiliate companies to better serve niche markets.

OEM Product Range with Calnetix Components and Systems								
Applications	Air/Gas Movement & Control	Compression	Fuel To Power	Pumping	Test Stands	Turbocharging & Supercharging	Turboexpansion	UAVs/Satellites
Industries	Chemical Defense Food Industrial Semiconductors Other	Defense HVACR Industrial Marine Oil & Gas Other	Oil & Gas Power Generation Vehicles Defense Other	Medical Oil & Gas Other	Vehicles Defense Other	High-Performance Vehicles/ Motorsports Marine On-Road Vehicles Off-Road Vehicles Power Generation Rail Other	Industrial Oil & Gas Power Generation Other	Aerospace Communications Defense Other
Products	Magnaforce™ Motors, Powerflux™ Bearings, Vericycle™ Drives	Magnaforce™ Motors, Powerflux™ Bearings, Vericycle™ Drives	Magnaforce™ Generators, Vericycle™ Drives	Magnaforce™ Motors, Vericycle™ Drives	Magnaforce™ Motor Generators, Powerflux™ Bearings, Vericycle™ Drives	Magnaforce™ Motor Generators Vericycle™ Drives	Magnaforce™ Motor Generators, Powerflux™ Bearings, Vericycle™ Drives	Magnaforce™ Motor Generators, Powerflux™ Bearings



A Key Supplier of Components for High-Speed OEM Systems



High-Speed Electric Motor Generators

Calnetix Technologies designs, develops and manufactures a wide range of **Magnaforce™ Permanent Magnet (PM) Motor Generators** for a variety of applications and industries. These units range from only a few watts to megawatt power levels with speeds ranging from 4,000 rpm to 450,000 rpm. Whether converting mechanical power to electrical or converting electrical power to mechanical, Calnetix PM motor generators provide the following advantages:

- High-speed operation
- High system efficiency
- Optimized magnetic performance
- High-temperature operation
- Customization for targeted applications
- Direct variable speed drive to eliminate gearboxes
- Very compact size
- High availability and reliability
- Low noise and vibration
- Very cost-effective operation and lifetime costs

Calnetix's Magnaforce™ machines are comprised of PM rotors and companion stators for constant torque applications. Smaller rotors feature metal sleeve construction, while large units employ Calnetix's proprietary composite sleeve technology. Each companion stator is optimized to provide trouble-free service over an extended lifetime.

Calnetix's Magnaforce™ Components



Active Magnetic Bearings

Calnetix Technologies specializes in high-speed rotating machinery supported by patented active permanent magnet bias homopolar bearings. We offer Powerflux™ Magnetic Bearings in radial and side by side combination configuration. These are the most advanced active magnetic bearings in the market. The very unique advantages of Calnetix's magnetic bearings include the following:

- Permanent magnet (PM) bias
- Homopolar design
- Combining radial and axial bearing functions in one device
- Proprietary position sensors
- State-of-the-art approach to integrated machine design
- Advanced graphical user interface



To operate magnetic bearing systems, Calnetix has developed and deployed a line of advanced controllers called **Insight™ Magnetic Bearing Controllers (MBCs)**. Key subsystems include a digital signal processor (DSP) board with sensor demodulation electronics, power electronics and DC power supplies. These very compact controllers interact with the magnetic bearing actuators and shaft position sensors, which are located within the PM-driven machine. Calnetix's latest magnetic bearing controller, Insight™ 804, is the most advanced and compact controller available today.

Insight™ Magnetic Bearing Controllers





Innovation That Drives Industries®

A Key Supplier of Components for High-Speed OEM Systems

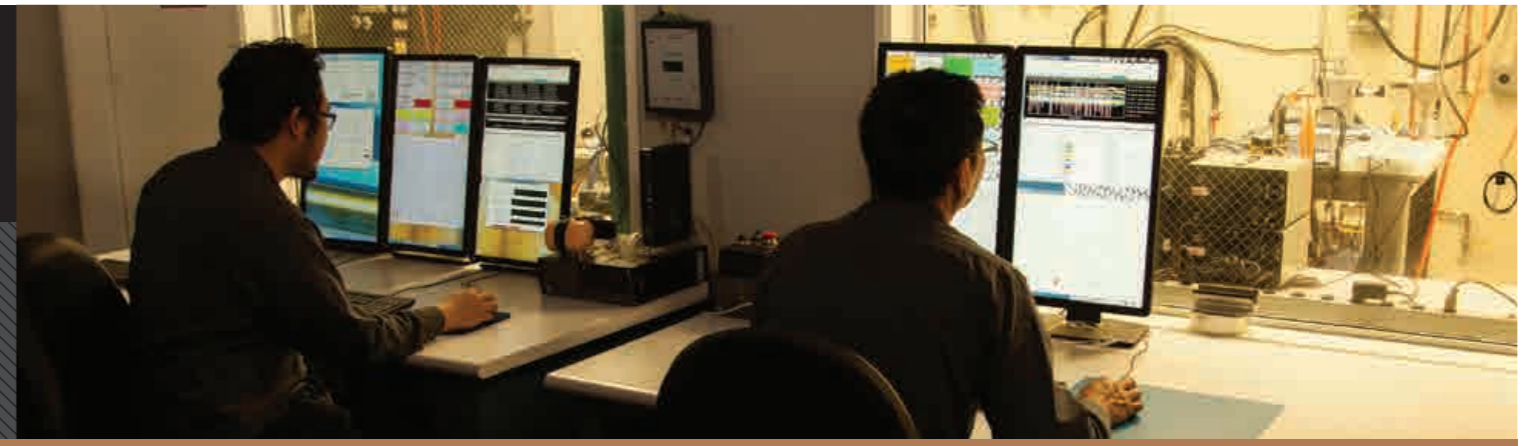

Power Electronics

By utilizing cutting-edge technology in motor drives and inverters, Calnetix Technologies is able to take full advantage of the latest technology in permanent magnet (PM) motor generators. Whether developing, integrating or manufacturing the necessary power electronics, Calnetix always designs with the system and application in mind. Vericycle™ Bidirectional Drives are the ideal choice for any type of high-speed rotating machinery. Calnetix offers both off-the-shelf and custom solutions and is committed to working in collaboration with our clients to deliver the highest quality products. Some of the key advantages of the Calnetix Vericycle™ Bidirectional Drives technology include:

- System level design optimization
- Low-impedance and high-speed machine optimization
- Sensorless control methodology
- Bidirectional operation
- Low total harmonics distortion (THD)
- High reliability and long operating life
- Sensorless space vector modulation
- Re-programmable for new applications
- Active or passive front end

Calnetix's Vericycle™ Bidirectional Drive Modules include identical and interchangeable three-phase active front-end and grid-tie inverters connected through a common DC bus. The inverters consist of Insulated Gate Bipolar Transistors (IGBTs) mounted on a liquid-cooled cold plate. Off-the-shelf modules meet the most stringent utility and grid requirements and are available with maximum current ratings of up to 900A.

In addition, Calnetix offers custom solutions by leveraging our existing technology and advanced engineering capabilities to provide custom designs that are cost effective, robust and delivered on time.

Vericycle™ Modules and Vericycle™ Bidirectional Drives

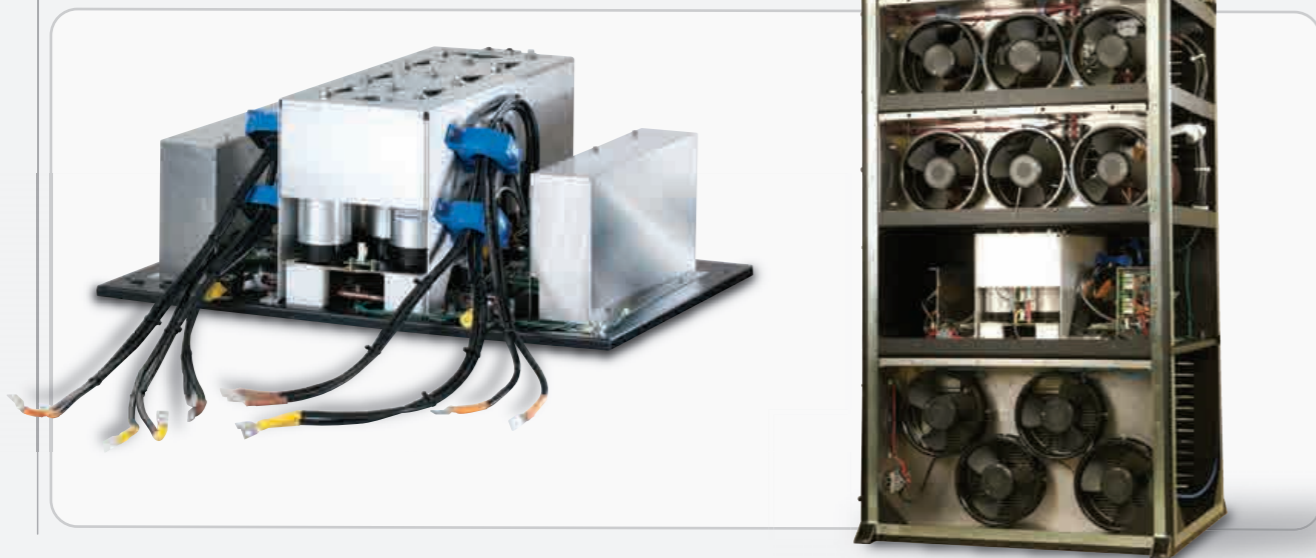

Research and Development

Calnetix has a technology suite to develop or improve high-speed OEM products with the necessary performance and cost advantages for successful market introduction and end user return on investment (ROI).

As technology continues to change, evolve and adapt in response to the need for more efficient use and recovery of energy, we continually work to maintain our leadership position in this area by investing heavily in internally funded research and development from three primary sources:

- Market driven requests for new applications of our technology
- Customer driven requests for enhanced or expanded performance of our products
- Internally driven requests for technology advancements to expand our market, improve our products and technology, and maintain our leadership position

Our current R&D activities are focused in several key areas:

- Enhanced motor generator capability for improved efficiency and operation in difficult environments, including:
 - » Enhancing our carbon fiber sleeving and composite technology to operate in extreme rotor temperatures and at higher tip speeds
 - » Adding motor generator mechanical features that reduce rotor heating to achieve zero airgap cooling needs
 - » Increasing stator operating temperatures for reduced cooling needs, and increasing machine operating frequencies while maintaining reliability
- Enhanced power electronics capabilities for improved efficiency and operation over extreme distances, including:
 - » Increasing our power electronics switching capability for higher efficiency and reduced rotor losses
 - » Advancing our sensorless motor control for enhanced machine diagnostic capabilities for proactive condition monitoring and long distance (step out) applications
 - » Moving the topology to high efficiency wide band gap devices
- Enhanced controls and sensor capabilities to achieve higher reliability for unmanned continuous operation:
 - » Advancing the capabilities of our PM biased active magnetic bearing technology to include supercritical operation above multiple rotordynamic bending modes
 - » Advancing diagnostic and prognostic capabilities of our motors and variable frequency drives
- Next generation integration to enable new applications:
 - » Fully integrated turbomachinery with electromagnetic and mechanical integration
 - » Integrated sensors and compensation devices
 - » Analyzing state-of-the-art materials for integration into our systems



Innovation That Drives Industries®

A Trusted OEM Partner



Product Development and System Integration

If you are looking for a technological edge to optimize your system or reduce the size of your product offering, withstand special operating conditions, improve maintainability, or simply decrease operating and/or maintenance costs, Calnetix can help.

Calnetix offers customers two convenient ways to employ our core competencies in developing: the most advanced high-speed OEM systems.

- Calnetix will provide a comprehensive turnkey system integration solution to a customer specified challenge using all of Calnetix's highly reliable core products – our permanent magnet (PM) motor generators, magnetic bearings and power electronics.
- Calnetix will provide integration support services to meld selected portions of our core products with customer designated hardware and software, working closely with customer engineering teams to improve the reliability and availability of the complete customer system.

Integrated Subsystems

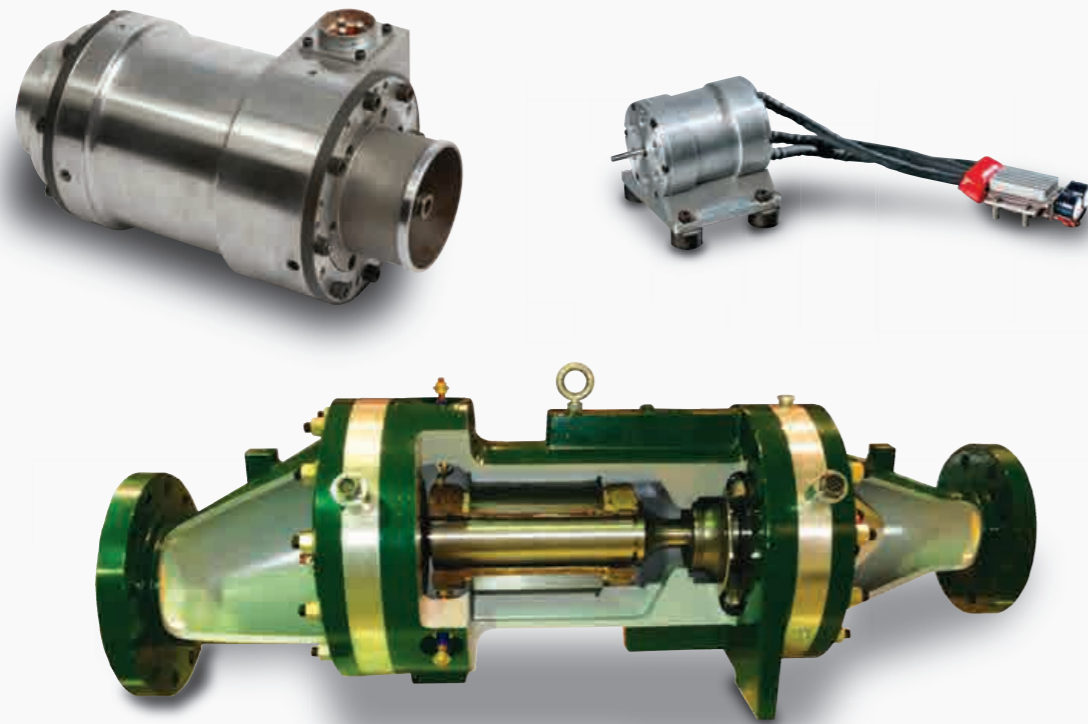

Calnetix Technologies' highly accomplished product development team is committed to a comprehensive design process that balances magnetic, thermal and structural factors to ensure an optimal design solution. Our in-house design and analysis capabilities include:

» Electromagnetic Analysis and Design

Calnetix utilizes both closed-form mathematical modeling and finite element method modeling. For motor generator designs, closed form computer models developed at Calnetix, based on permanent magnet synchronous machine theory, provide fast and accurate tradeoff studies of machine parameters, such as number of poles, stator and rotor topologies, stator winding configuration, materials selection and machine aspect ratios. Magnetic Bearing design and analysis software is based on a proprietary approach utilizing both analytical closed-form modeling and finite element analysis in tandem to generate an optimal electromagnetic design and accurately predict its performance parameter.

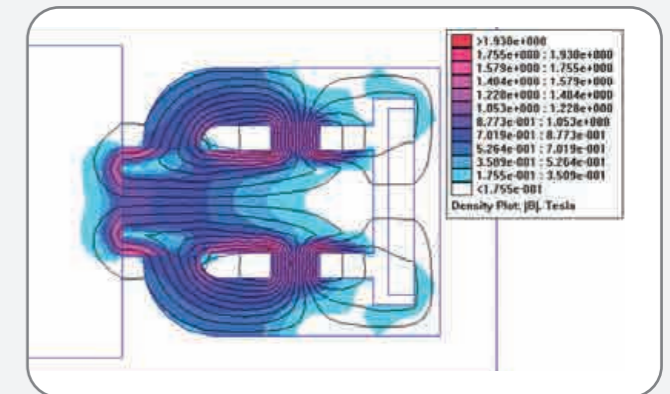

» Mechanical Analysis

Calnetix utilizes Solidworks software for complete 3D modeling of machines in design. Many of the models and assemblies are then used for fluid flow, stress, and thermal analyses and can be translated into CNC machining and CMM inspection models. During the design process, our customers approve interface control drawings, which can include exchanging 3D interface models (STEP, IGES, other) to ensure that the designed system meets all of their mechanical interface requirements. This has proven to be especially beneficial in sophisticated interface situations, such as in motorsports vehicle integration.

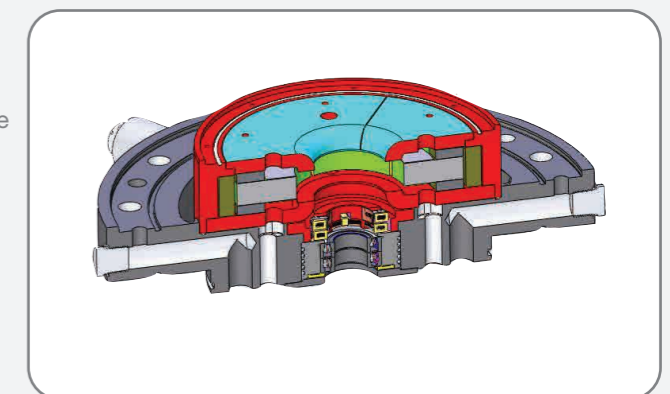

A Trusted OEM Partner

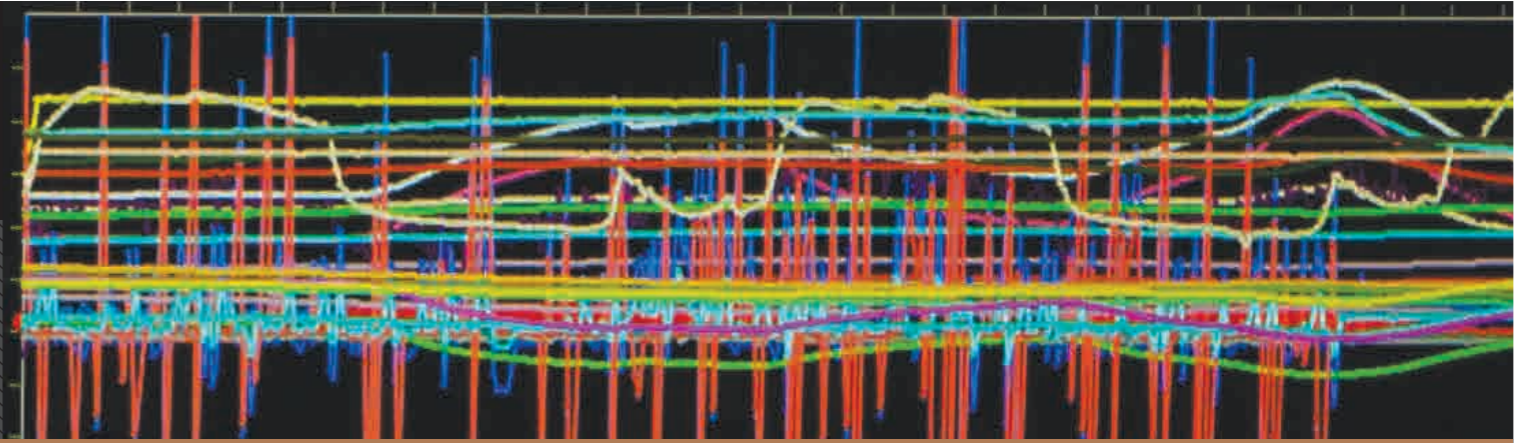

» **Rotordynamic Analysis**

Calnetix Magnetic Bearing Controllers and Motor Drives employ embedded controls to perform dedicated control functions specific to Calnetix designed motor generator and bearing performance needs. Calnetix develops its own embedded hardware and associated software to address the needs of complex electrical, mechanical and system design and integration requirements. Calnetix employs two development platforms based on the Texas Instruments (TI) DSP and the Motorola Freescale DSP for its magnetic bearing controllers and motor drives respectively. These embedded controllers feature high-speed DSP, PWM drives, analog and digital I/Os, and on-board flash and RAM. The user can control and monitor the embedded controllers by using Modbus through RS485/232 or digital/analog I/Os. Ethernet or USB port interfaces are also available.

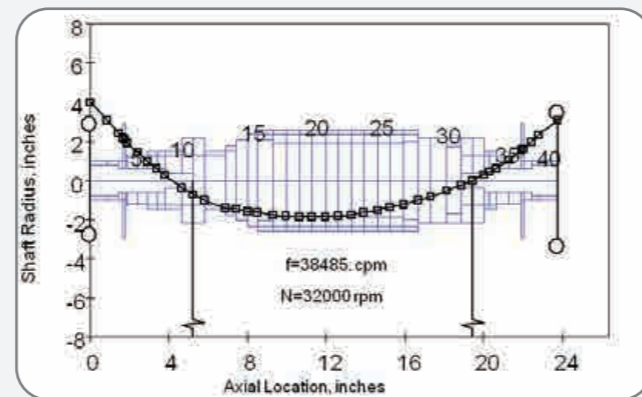

» **Stress Analysis**

As part of high-speed rotating machinery development programs, Calnetix Technologies provides the necessary experience, process and attention to detail for correct integration of components into a complex machine. Experienced design and analysis engineers work together with a portfolio of advanced materials and state-of-the-art analysis tools. This includes designing and analyzing the rotating and structural components for overloads using finite element analysis, modal analysis, heat transfer and computational fluid dynamics. The final design is an optimized machine that meets all service requirements.

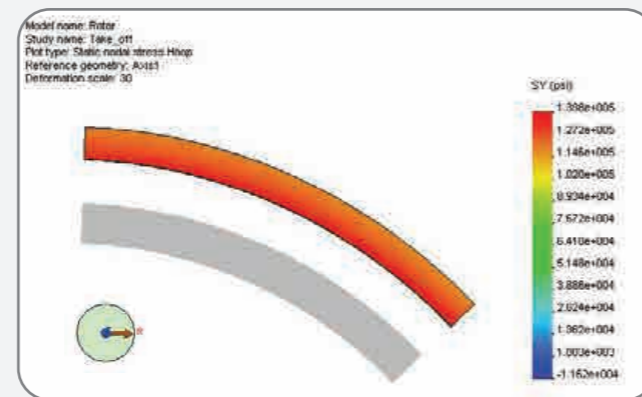

» **Embedded Control System Design**

Calnetix Magnetic Bearing Controllers and Motor Drives employ embedded controls to perform dedicated control functions specific to Calnetix designed motor generator and bearing performance needs. Calnetix develops its own embedded hardware and associated software to address the needs of complex electrical, mechanical and system design and integration requirements. Calnetix employs two development platforms based on the Texas Instruments (TI) DSP and the Motorola Freescale DSP for its magnetic bearing controllers and motor drives respectively. These embedded controllers feature high-speed DSP, PWM drives, analog and digital I/Os, and on-board flash and RAM. The user can control and monitor the embedded controllers by using Modbus through RS485/232 or digital/analog I/Os. Ethernet or USB port interfaces are also available.

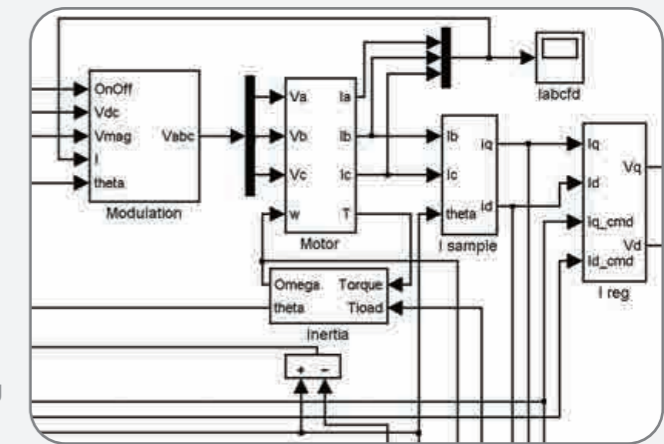

» **Power Electronics/Motor Controller Design**

Calnetix's Sine modulated PWM drives utilize space vector based switching controls to reduce the current harmonics in the motor. Motors are designed with these harmonics in mind to ensure that the system will operate at peak performance. The drive consists of rectifier and Inverter modules, which are similar in design, construction and configuration, and therefore are capable of bidirectional power flow operation (motoring mode or generation mode). Besides the existing line of drives and inverters, Calnetix designs and manufactures custom electronics for niche applications in various industries.

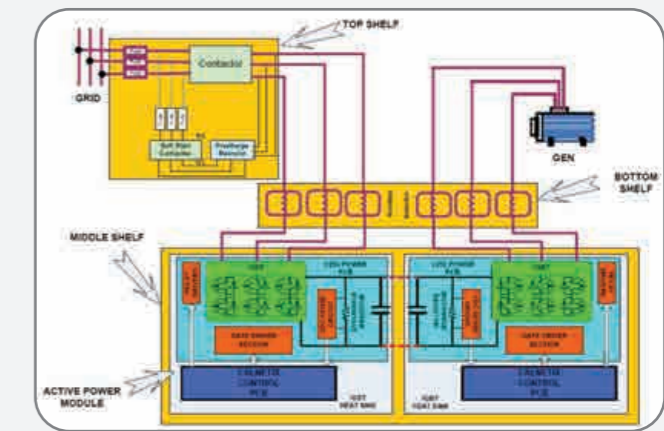



Innovation That Drives Industries®

High-Value Manufacturing and Full Life Cycle Support



Manufacturing and Testing

Calnetix is **ISO (International Standards Organization) 9001:2008 certified for design and manufacturing.**

Our robust quality system ensures that all products meet design requirements, regulatory requirements and user needs. All of Calnetix's production lines are designed to be scalable, with production staff cross trained for further flexibility in factory floor loading. Calnetix's 7+ acre headquarters and assembly facility is located in Cerritos, CA. Our in-house manufacturing capabilities include:

- CNC and high precision machining (+/- 0.0001)
 - » Full capability machine shop, CNC and conventional
- Fabrication of tools (designed in-house by our manufacturing engineers)
- Turning and grinding of rotors
 - » Mori Seiki NL 2500 CNC Lathe
 - » Studer S33 CNC Grinder
 - » Kellenberger Kel-Varia CNC Grinder
- Rotor and stator assembly
- Rotor sleeving
- Rotor balancing
 - » Schenck Horizontal Balancing Machines (22 - 500 lb.) capabilities
- Motor generator assembly and test
- Power electronics assembly and test (Multi-MW power range)
- Actuator assembly and test
- Magnetic bearing assembly and test



Quality

Calnetix Technologies is dedicated to meeting and exceeding customer expectations by providing quality products and services and by striving to continuously improve our engineering design and manufacturing capabilities.

Our quality management system (QMS) is certified to ISO 9001:2015 and enables us to design and produce the highest quality products, provide the best service and offer the best value to the customer. From estimating proposals, purchasing, production planning and control to manufacturing, inspection, packaging and shipping, our QMS provides the controls necessary to ensure that products comply with applicable customer and regulatory requirements, and provides the framework to continually improve processes and customer satisfaction.

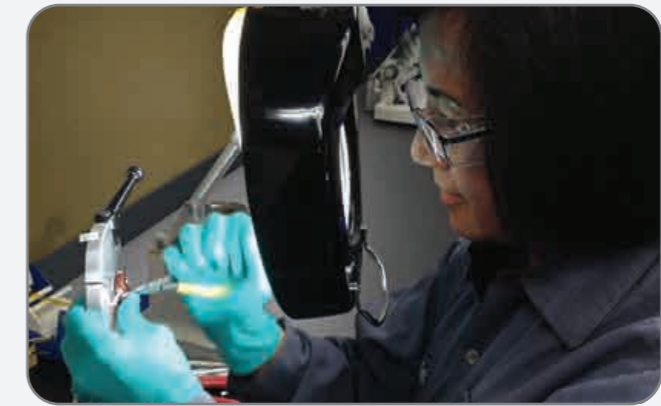

Safety

Calnetix Technologies is dedicated to ensuring the health and safety of all employees and visitors in our facility. Calnetix has a standing safety committee to address safety concerns and OSHA compliance on our campus. Our safety committee is responsible for updating and maintaining our safety program documents, developing policies to ensure the safety of all employees in our facility, promoting general employee health and wellness and responding to all safety concerns identified by employees or during periodic facility walkthroughs.



Innovation That Drives Industries®

16323 Shoemaker Avenue | Cerritos, CA 90703 USA

Phone: +1.562.293.1660 | **info@calnetix.com**

www.calnetix.com